

DHI-SSD-V800

2.5 inch SATA Solid State Drive



V800 Series 2.5 inch SATA Solid State Drive

System Overview

As a new generation of 2.5" SSD product, V800 series SSD adopts high-quality 3D TLC NAND and professional controller, and is widely used in surveillance system, ideally compatible with Dahua XVR product. V800 series SSD provides safe and reliable data transmission and effectively deals with various special conditions in surveillance such as data flow and full coverage.

Scene

It is suitable for XVR devices with 2.5" SATA ports.

Technical Specification

Technical

Product Model	DHI-SSD-V800S256G	DHI-SSD-V800S512G	DHI-SSD-V800S1TB
Capacity ¹	256GB	512GB	1TB
Form Factor	2.5 inch		
Port	SATAIII 6Gb/s		
Net Weight	Max 40 g (0.09 lb)		
Product Dimensions	100.20 mm × 69.90 mm × 7.00 mm (3.94" × 2.75" × 0.28")		
Packaging Dimensions	575.00 mm × 262.00 mm × 153.00 mm (22.63" × 10.31" × 6.02")		
Component	3D NAND		
Power Consumption ²	1100 mW (max) 620 mW (Avg) 500 mW (idle)	1200 mW (max) 625 mW (Avg) 500 mW (idle)	1100 mW (max) 950 mW (Avg) 500 mW (idle)
S.M.A.R.T	Support		
TRIM	Support		

- Adopts high-quality wafer level chip.
- Provides better read and write performance with TRIM and NCQ.
- Low power consumption management.
- Safe and reliable data transmission.
- With stable read and write performance, it is suitable for 24/7 recording and storage of XVR without frame loss.

Garbage Collection	Support		
Sequential Read ²	Up to 550MB/s	Up to 550MB/s	Up to 550MB/s
Sequential Write ²	Up to 170MB/s	Up to 330MB/s	Up to 450MB/s
4K Random Read ²	Up to 45000	Up to 60000	Up to 61000
4K Random Write ²	Up to 34000	Up to 47000	Up to 56000
MTBF	1,500,000 hours		
Operating Temperature	0°C to +70°C (+32°F to +158°F)		
Storage Temperature	-40°C to +85°C (-40°F to +185°F)		
Operating Humidity	5%–95% (non-condensing)		
Vibration Resistance	10–1000 Hz, 2.78G		
TBW	230TB	465TB	930TB
Warranty ³	3-year limited warranty		
Reference Information	1. Capacity calculation: 1GB = 1 billion bytes (IDEMA). Actual available capacity might be reduced (due to formatting, partition, operating system applications, or other necessary usage). 2. The speed data comes from Zhejiang Huayixin Technology Co., Ltd. Lab. System configuration of performance test: Intel Z390 Chipset, Intel Core i9-9900KF@3.6GHz, 16GB DDR4; operating system-Windows 10 x64; testing tool-CrystalDiskMark 6.0.0. 3. Warranty period or maximum write amount (TBW), whichever comes first.		

Ordering Information

Type	Model	Description
V800 SERIES	DHI-SSD-V800S256G	Dahua 2.5 inch SATA Solid State Drive 256GB Dramless 0~70°C 30μ"VIDEO GRADE
	DHI-SSD-V800S512G	Dahua 2.5 inch SATA Solid State Drive 512GB Dramless 0~70°C 30μ" VIDEO GRADE
	DHI-SSD-V800S1TB	Dahua 2.5 inch SATA Solid State Drive 1TB Dramless 0~70°C 30μ" VIDEO GRADE

Installation

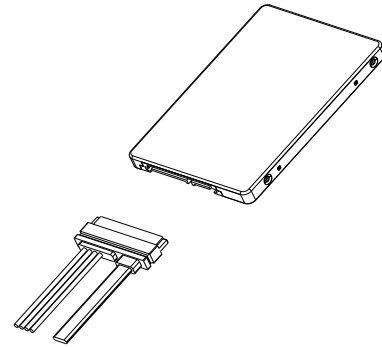

Dimensions (mm[inch])

